

## RONDO 6" CEILING BAR ( ARCB6 )

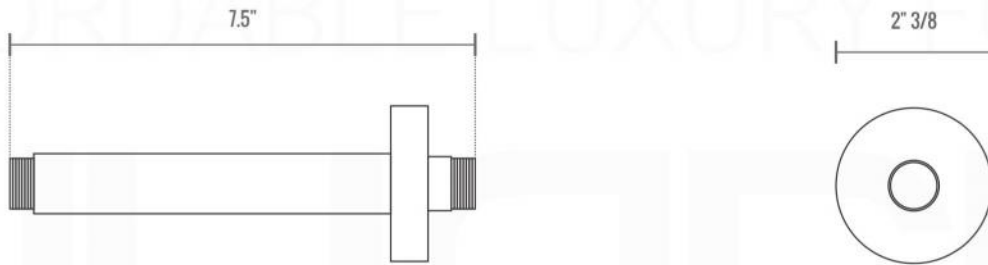

## RONDO HAND SHOWER SET ( ARHH123 )

**HAND HELD**

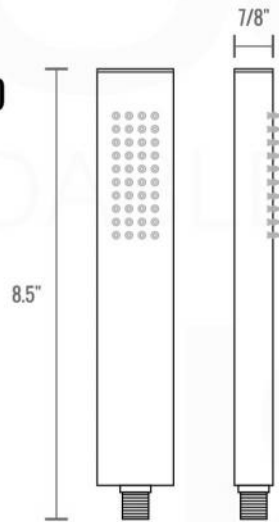

**PLATE**

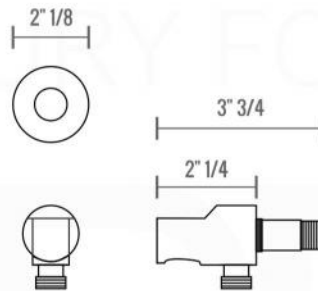

**WATER OUTLET ADAPTOR**

**FLEXIBLE HOSE**

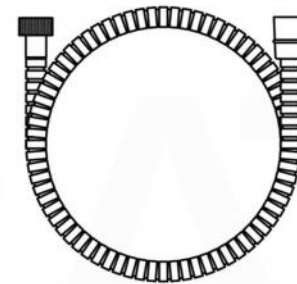

## RONDO RAIN SHOWER HEAD ( ARR12 )

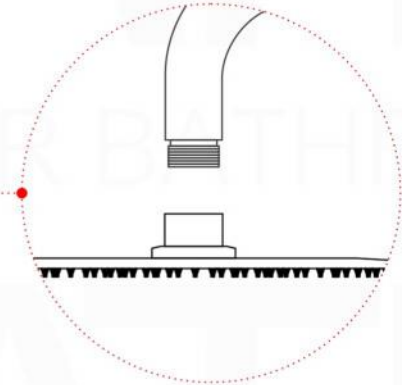
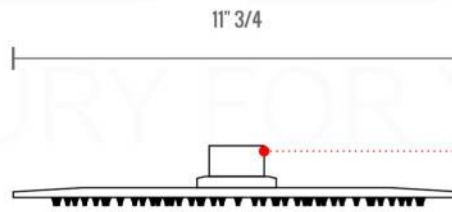
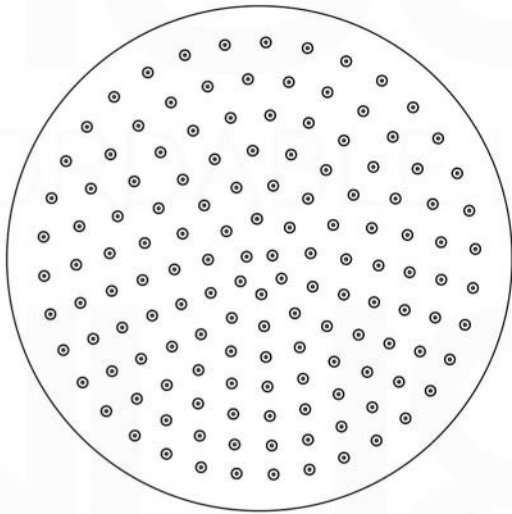

# RONDO 3 WAY VALVE (ARRS3V)

## FRONT VIEW

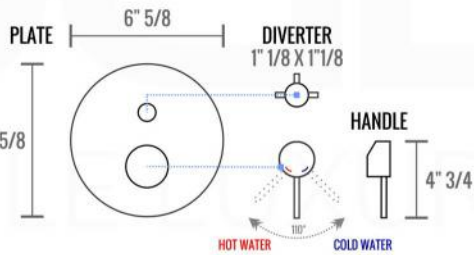
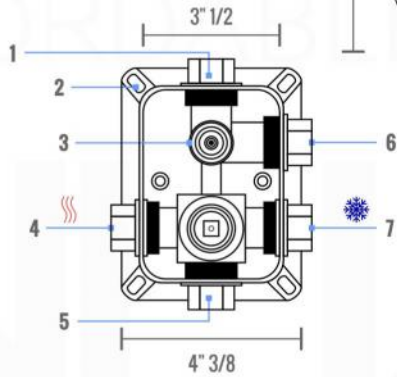

- 1- UPPER END OUTLET PIPE INTERFACE
- 2- MOUNTING FIXED HOLE
- 3- DIVERTER
- 4- HOT WATER PIPE INTERFACE
- 5- LOWER END OUTLET INTERFACE
- 6- HANDHELD SHOWER CONNECTION PORT
- 7- COLD WATER PIPE INTERFACE

## PROTECTION COVER

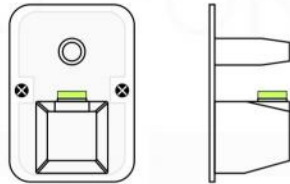

## LEFT VIEW

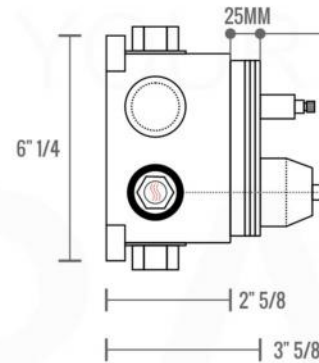

THIS LINE ON:

SAME SURFACE AS RAW WALL WHEN SET IN.  
CUT TO BE ON SAME SURFACE OF CERAMIC | EXTRA 25MM FOR CERAMIC

## RIGHT VIEW

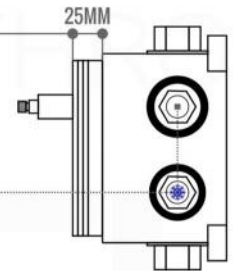

## RONDO TUB FILLER ( ARTF8 )

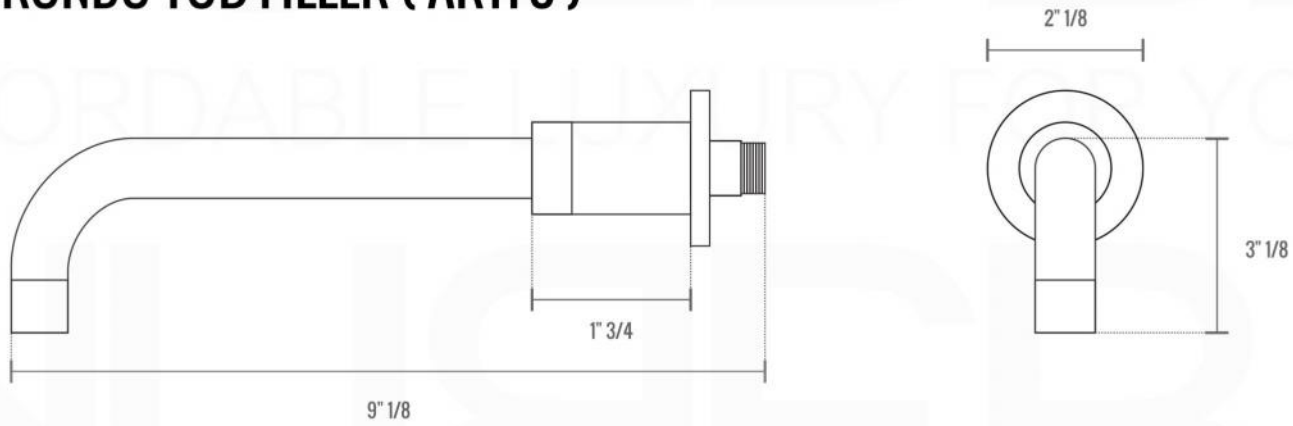

## RONDO 2 WAY VALVE (ARRS2V)

### CONFIG.01

RAIN SHOWER W/HANDHELD

### CONFIG.02

RAIN SHOWER W/TUB FILLER

### CONFIG.03

RAIN SHOWER W/BODY JETS

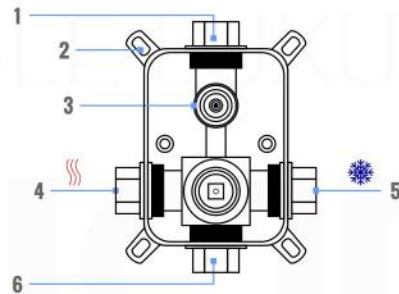

- 1 - UPPER END OUTLET PIPE INTERFACE
- 2 - MOUNTING FIXED HOLE
- 3 - DIVERTER
- 4 - HOT WATER PIPE INTERFACE
- 5 - COLD WATER PIPE INTERFACE
- 6 - LOWER END OUTLET INTERFACE

### CONFIG.01

RAIN SHOWER W/HANDHELD



### CONFIG.02

RAIN SHOWER W/TUB FILLER



### CONFIG.03

RAIN SHOWER W/BODY JETS

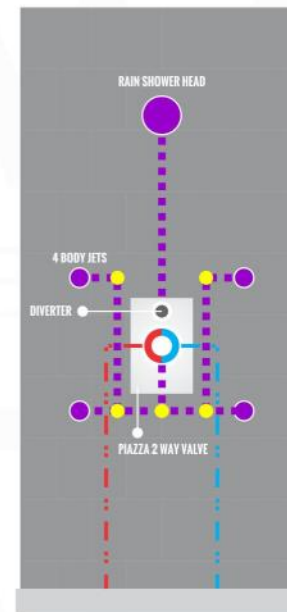

## RONDO 3 WAY VALVE (ARRS3V)

### CONFIG.01

RAIN SHOWER W/HANDHELD AND TUB FILLER

### CONFIG.02

RAIN SHOWER W/HANDHELD AND MESSAGE BODY JETS

### CONFIG.03

RAIN SHOWER W/TUBE FILLER AND MESSAGE BODY JETS

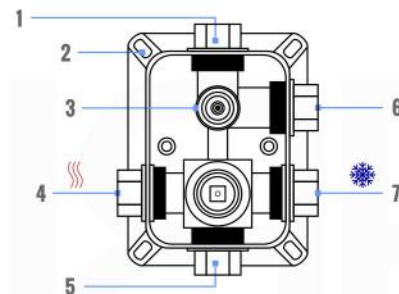

- 1 - UPPER END OUTLET PIPE INTERFACE
- 2 - MOUNTING FIXED HOLE
- 3 - DIVERTER
- 4 - HOT WATER PIPE INTERFACE
- 5 - LOWER END OUTLET INTERFACE
- 6 - HANDHELD SHOWER CONNECTION PORT
- 7 - COLD WATER PIPE INTERFACE

### CONFIG.01

RAIN SHOWER W/HANDHELD AND TUB FILLER

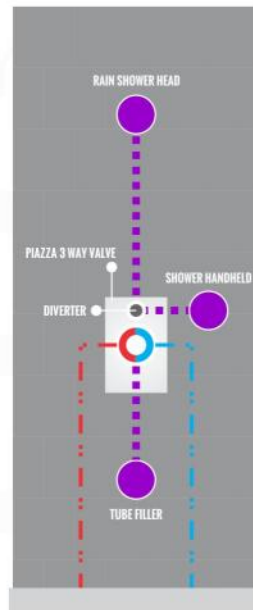

### CONFIG.02

RAIN SHOWER W/HANDHELD AND MESSAGE BODY JETS

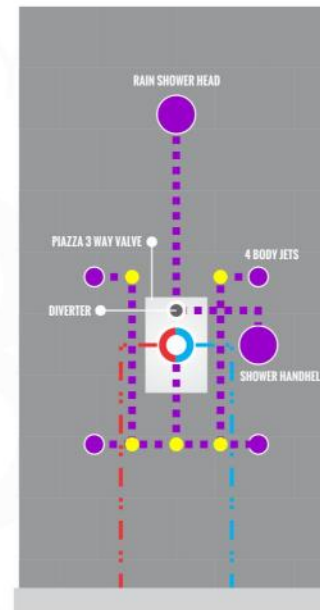

### CONFIG.03

RAIN SHOWER W/TUBE FILLER AND MESSAGE BODY JETS

