

RONDO 6" CEILING BAR (ARCB6)

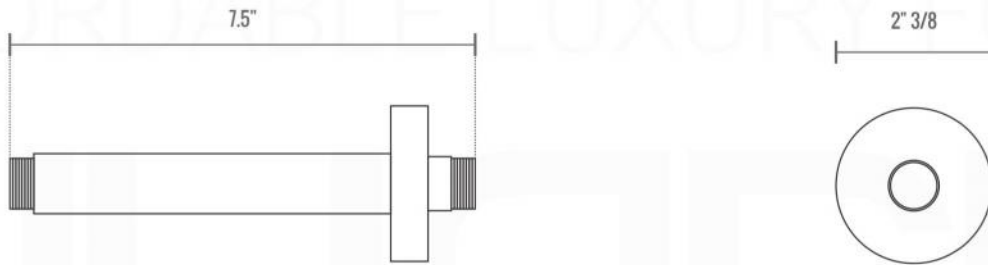

RONDO HAND SHOWER SET (ARHH123)

HAND HELD

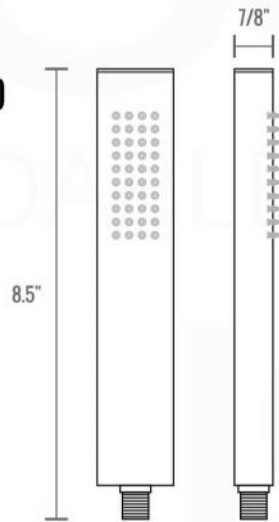

PLATE

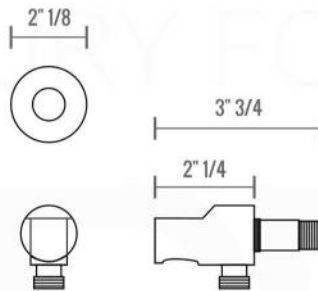

WATER OUTLET ADAPTOR

FLEXIBLE HOSE

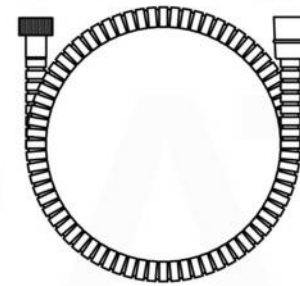

RONDO RAIN SHOWER HEAD (ARR8)

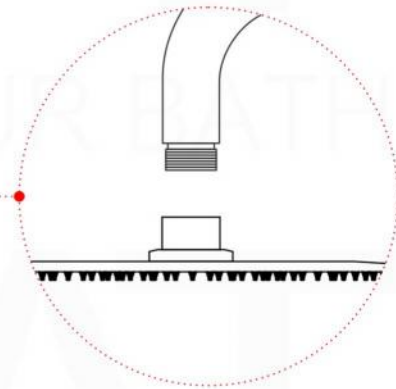
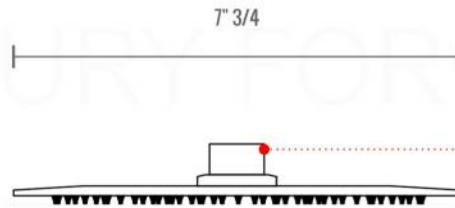
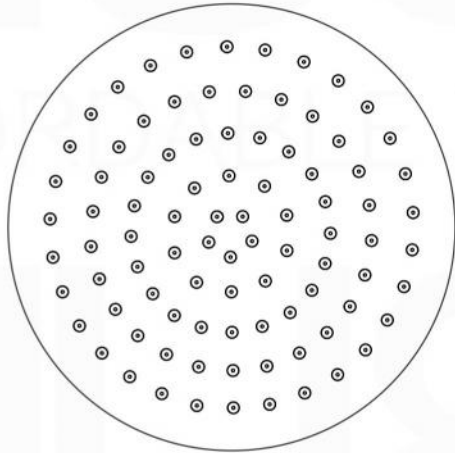

RONDO 3 WAY VALVE (ARRS3V)

FRONT VIEW

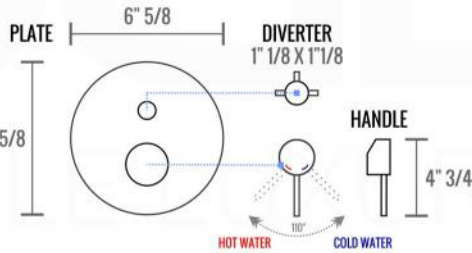
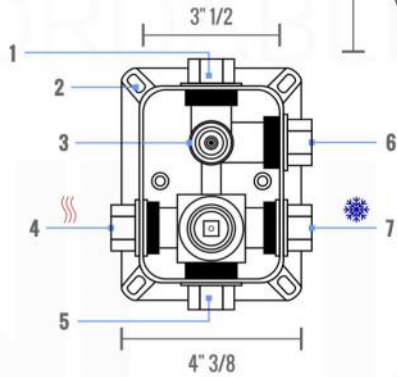

- 1- UPPER END OUTLET PIPE INTERFACE
- 2- MOUNTING FIXED HOLE
- 3- DIVERTER
- 4- HOT WATER PIPE INTERFACE
- 5- LOWER END OUTLET INTERFACE
- 6- HANDHELD SHOWER CONNECTION PORT
- 7- COLD WATER PIPE INTERFACE

PROTECTION COVER

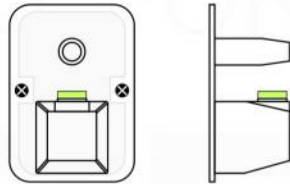

LEFT VIEW

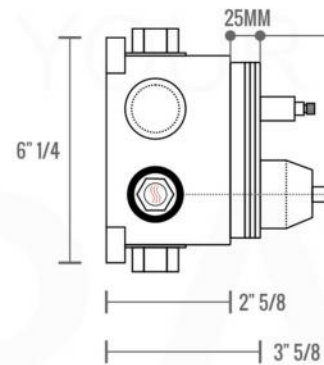

RIGHT VIEW

THIS LINE ON:
SAME SURFACE AS RAW WALL WHEN SET IN.
CUT TO BE ON SAME SURFACE OF CERAMIC | EXTRA 25MM FOR CERAMIC

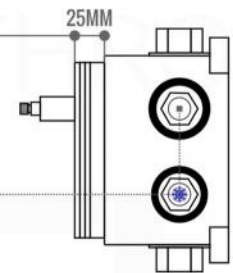

RONDO TUB FILLER (ARTF8)

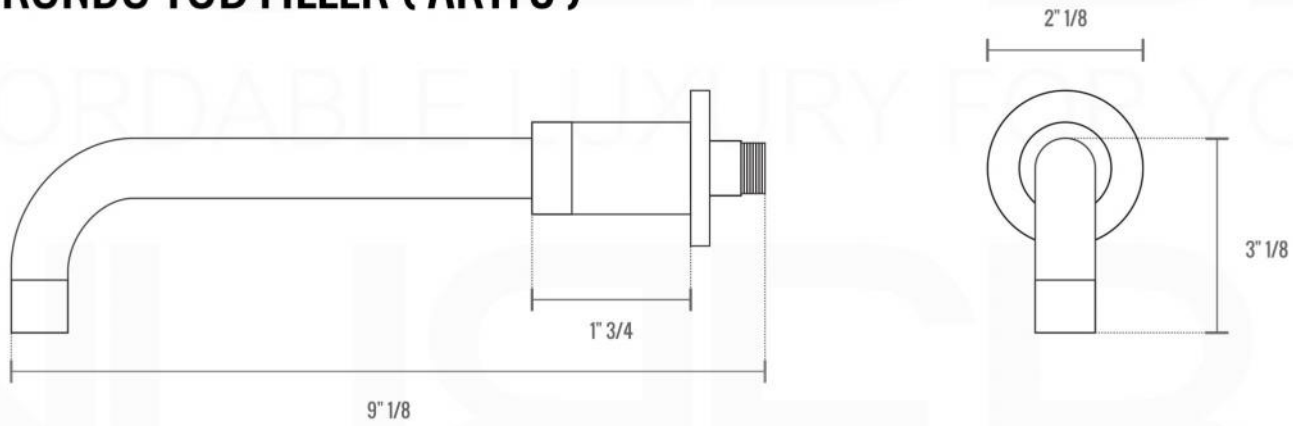

RONDO 2 WAY VALVE (ARRS2V)

CONFIG.01

RAIN SHOWER W/HANDHELD

CONFIG.02

RAIN SHOWER W/TUB FILLER

CONFIG.03

RAIN SHOWER W/BODY JETS

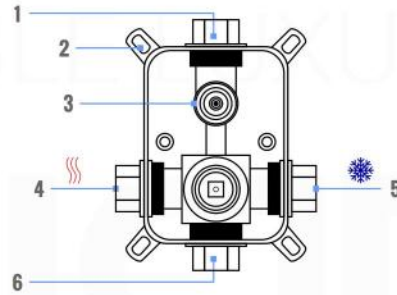

- 1 - UPPER END OUTLET PIPE INTERFACE
- 2 - MOUNTING FIXED HOLE
- 3 - DIVERTER
- 4 - HOT WATER PIPE INTERFACE
- 5 - COLD WATER PIPE INTERFACE
- 6 - LOWER END OUTLET INTERFACE

CONFIG.01

RAIN SHOWER W/HANDHELD

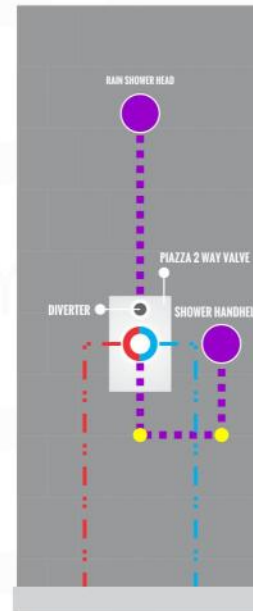

CONFIG.02

RAIN SHOWER W/TUB FILLER



CONFIG.03

RAIN SHOWER W/BODY JETS

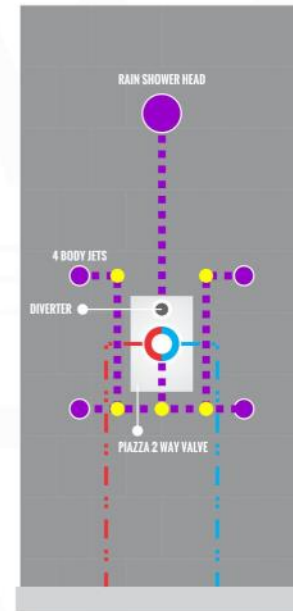

RONDO 3 WAY VALVE (ARRS3V)

CONFIG.01

RAIN SHOWER W/HANDHELD AND TUB FILLER

CONFIG.02

RAIN SHOWER W/HANDHELD AND MESSAGE BODY JETS

CONFIG.03

RAIN SHOWER W/TUBE FILLER AND MESSAGE BODY JETS

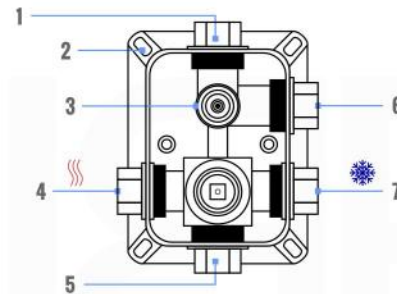

- 1 - UPPER END OUTLET PIPE INTERFACE
- 2 - MOUNTING FIXED HOLE
- 3 - DIVERTER
- 4 - HOT WATER PIPE INTERFACE
- 5 - LOWER END OUTLET INTERFACE
- 6 - HANDHELD SHOWER CONNECTION PORT
- 7 - COLD WATER PIPE INTERFACE

CONFIG.01

RAIN SHOWER W/HANDHELD AND TUB FILLER



CONFIG.02

RAIN SHOWER W/HANDHELD AND MESSAGE BODY JETS

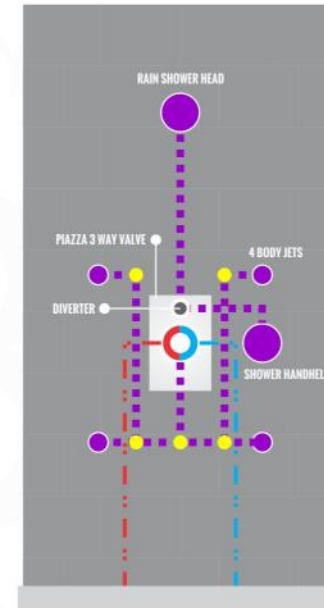

CONFIG.03

RAIN SHOWER W/TUBE FILLER AND MESSAGE BODY JETS

