

KFST4660

Dimensions:	width	depth	height
inches	59"	28"	26.4"
mm	1500	715	670

NOTE: DIMENSIONS AND TECHNICAL DETAILS ARE SUBJECT TO CHANGE WITHOUT NOTICE

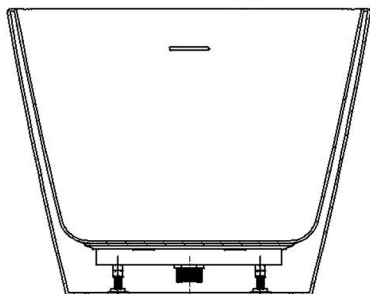
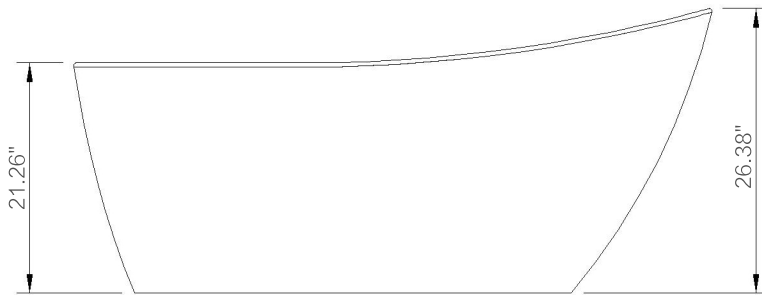
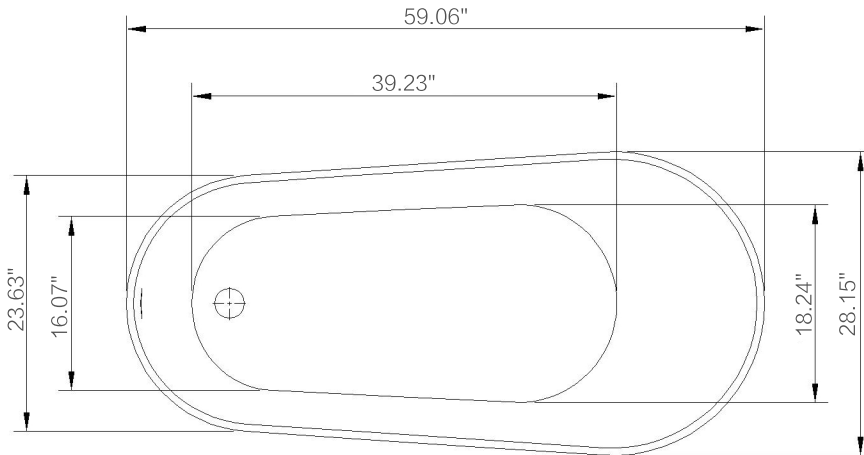

Features:

- . Reinforced Acrylic Composite Construction
- . Slim Rectangular Overflow - Chrome Finish
- . Warm to Touch, Easy to Clean, Won't Fade, Easy to Repair
- . High Thermal Water Heat Retention
- . Level Adjustment Feet
- . Brass Pop-Up Drain Included - Chrome Finish
- . Capacity: 55 Gallons
- . cUPC Approved

Freestanding Bathtub INSTALLATION AND CARE GUIDE

PREPARATION

1. Clean, level, and prepare the floor for installation.
2. Place the unit in the exact installed position on the floor and trace the outline of the bathtub with a pencil or any erasable marking.
3. Determine the location of the drain pipe, on the floor by taking measurements of the drain and waste location underneath the unit (figure 2).
4. Using a blanket, cardboard, or other clean protective surface, turn the unit on its side so that the unit is properly supported during drain installation.
5. Clean the drain hole area in preparation of setting the drain. The area should be dry and free of any debris.

INSTALL DRAIN HARDWARE

6. Apply plumbers putty around the Drain Body and pass it through the drain hole (figure 3).
7. Apply plumbers putty to the Washer and slide it over the bottom of the Drain Body (figure 3).
8. Slide the paper washer over the drain body.
9. Attach the Drain Body Nut on the Drain Body and tighten until the Nut and Washer have created a seal with the bottom of the bathtub. **DO NOT OVERTIGHTEN** (figure 4).

PREPARE TAIL PIECE

All parts involved in tail piece installation are provided by the installer.

10. Drain waste vent must always be installed according to local standard. Verify the placement of the bathtub before drilling the hole for the drain waste vent.
11. Install 1 1/2" rubber slip gasket over the drain waste vent (figure 5).
12. Cut tail piece to desired length (will vary for each installation).
13. Slide tail piece nut over tail piece towards flanged end.
14. Connect tail piece assembly to waste vent.
15. Place flange washer on top of tail piece.

INSTALL BATHTUB

17. Apply a generous bead of adhesive or silicone to the bottom of the tub legs (figure 6).
18. Then apply a bead of tub and tile caulk around the edge of the base (figure 6).
19. Carefully set tub into position (figure 7) and connect the drain hardware (previously installed). Finish the installation of the tail piece installation.

COMPLETE BATHTUB - INSTALLATION

20. Fill the tub with water to the overflow and then drain the tub while inspecting the waste connections below the floor for leaks. Access from below will be necessary for this step (figure 8).
21. With the bathtub now in place, wipe off any excess tub and tile caulk and adhesive where the tub meets the floor.
22. Run a bead of tub and tile caulk around the bottom edge of the bathtub where it meets the floor. Wipe off any excess caulk with a wet cloth (figure 9).

Figure 01

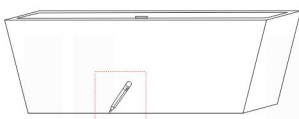

Figure 02

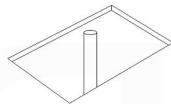

Figure 03



Figure 04

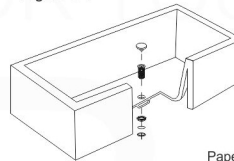

Figure 05

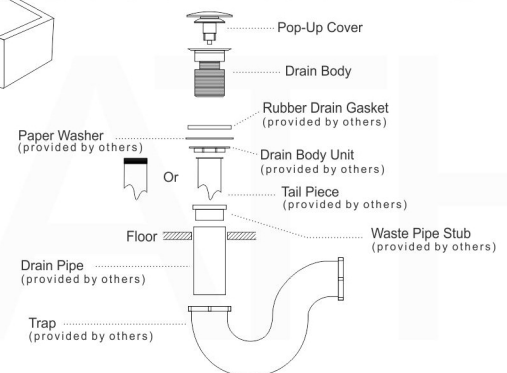

Figure 06

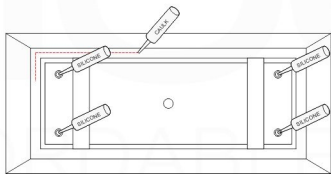

Figure 07

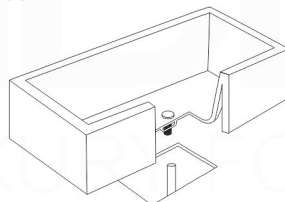

Figure 08

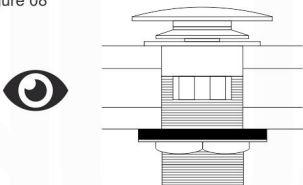
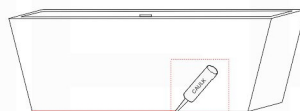

Figure 09



KubeBath Bathtubs are easy to clean: after each use, simply wipe with a soft cloth to remove any surface dirt. For day to day cleaning we recommend using of widely available mild soap cleaning product. Never use petroleum-based products when cleaning, such as paint thinners or other solvents as they may damage the solid surface. **Note:** Personal hygiene products and cosmetics will Not damage the surface.

Scratched or Damaged Surfaces:

Avoid using razor blades or other sharp objects that might scratch the surface. Most minor scratches (up to 1/64") and cigarette burns can be removed by sanding the area with #180 or #240 wet or dry sandpaper and progressing down to #600 or #1200 grit. Finally, apply a light buffing compound and buff area with a clean stitched cotton buffing pad or equivalent. Use an extra application of fine buffing compound if necessary.